



BMW SERIA 3 E46 4D coupe
BMW SERIA 3 E46 compact

04/1998 - 2005
06/2001 - 2005

Cat. No. **B/007**

e20

e20*94/20*0514*00

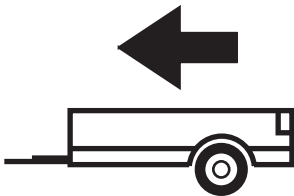

1800kg

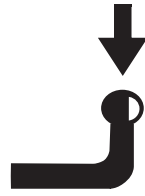

75kg

D = 9,51kN

D (kN) =



MAX kg

x

MAX kg

x 0,00981



MAX kg

+

MAX kg



IMIOLA HAK-POL

96-111 KOWIESY, CHOJNATA 23A, POLAND

Tel. + 48 46 831 73 31, fax +48 831 74 29

e-mail: office@imiola.pl, www.imiola.pl



PRZEKRÓJ A-A

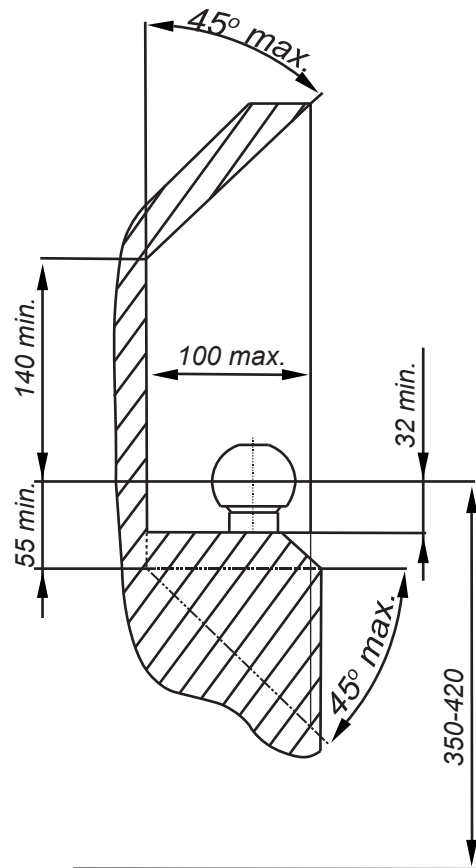

PL Należy zagwarantować przestrzeń swobodną według załącznika VII, rysunek 25a/b Regulaminu EKG ONZ 55.01 przy dopuszczalnym ciężarze całkowitym pojazdu.

F L'espace libre doit être garanti conformément à l'annexe VII, illustration de la réglementation 55.01 CE pour un poids total en charge autorisé du véhicule.

GB The clearance specified in appendix VII, diagram 25a/b of Regulation No. 55.01 UN EU must be guaranteed at laden weight of the vehicle.

D Der Freiraum nach Anhang VII, Abbildung 25a/b der Vorschriften 55.01 EG ist zu gewährleisten bei zulässigem Gesamtgewicht des Fahrzeuges.

Moment skręcający dla śrub i nakrętek (8.8) Torque settings for nuts and bolts (8.8)	
M8	25Nm
M10	55Nm
M12	85Nm
M14	135Nm
M16	195Nm



Šruba M10x50-8.8 ; Bolt
 Podkl. sprež. 10,2 ; Spring Washer
 Podkl. okr. Ø30xØ10,5x3 ; Plain Washer









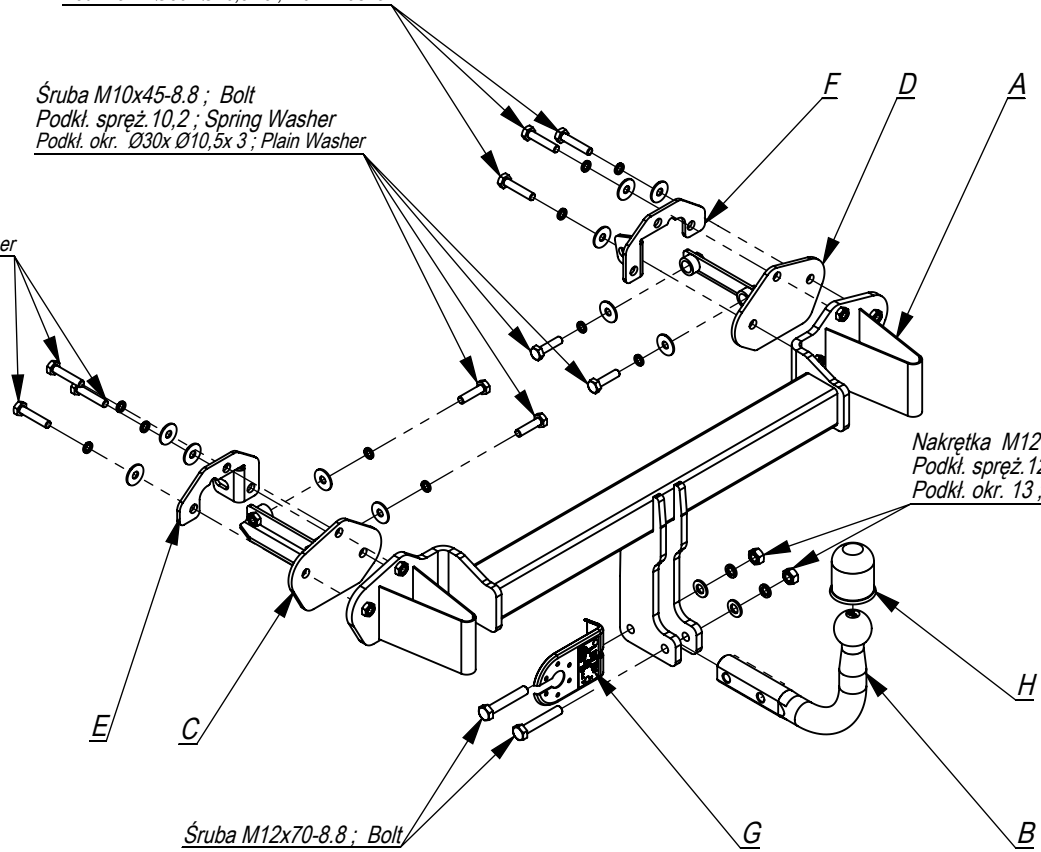

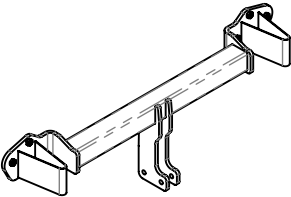
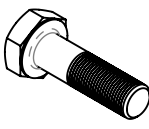
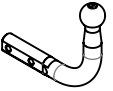
Šruba M10x45-8.8 ; Bolt
 Podkl. sprež. 10,2 ; Spring Washer
 Podkl. okr. Ø30xØ10,5x3 ; Plain Washer

Šruba M10x50-8.8 ; Bolt
 Podkl. sprež. 10,2 ; Spring Washer
 Podkl. okr. Ø30xØ10,5x3 ; Plain Washer

Nakrętka M12 : Nut
 Podkl. sprež. 12,2 ; Spring Washer
 Podkl. okr. 13 ; Plain Washer

Šruba M12x70-8.8 ; Bolt



	A	x1		M12x70	2
				M10x50	6
				M10x45	4
	B	x1		M12	2
				Ø30xØ10,5x3	10
	C	x1		13	2
				12,2	2
	D	x1		10,2	10
	E	x1			
	F	x1			
	G	x1			
	H	x1			

Śruba M10x50-8.8 ; Bolt
Podkł. spręż. 10.2 ; Spring Washer
Podkł. okr. Ø30x Ø10,5x 3 ; Plain Washer

Śruba M10x45-8.8 ; Bolt
Podkł. spręż. 10.2 ; Spring Washer
Podkł. okr. Ø30x Ø10,5x 3 ; Plain Washer

Śruba M10x50-8.8 ; Bolt
Podkł. spręż. 10.2 ; Spring Washer
Podkł. okr. Ø30x Ø10,5x 3 ; Plain Washer

Nakrętka M12 ; Nut
Podkł. spręż. 12,2 ; Spring Washer
Podkł. okr. 13 ; Plain Washer

Śruba M12x70-8.8 ; Bolt

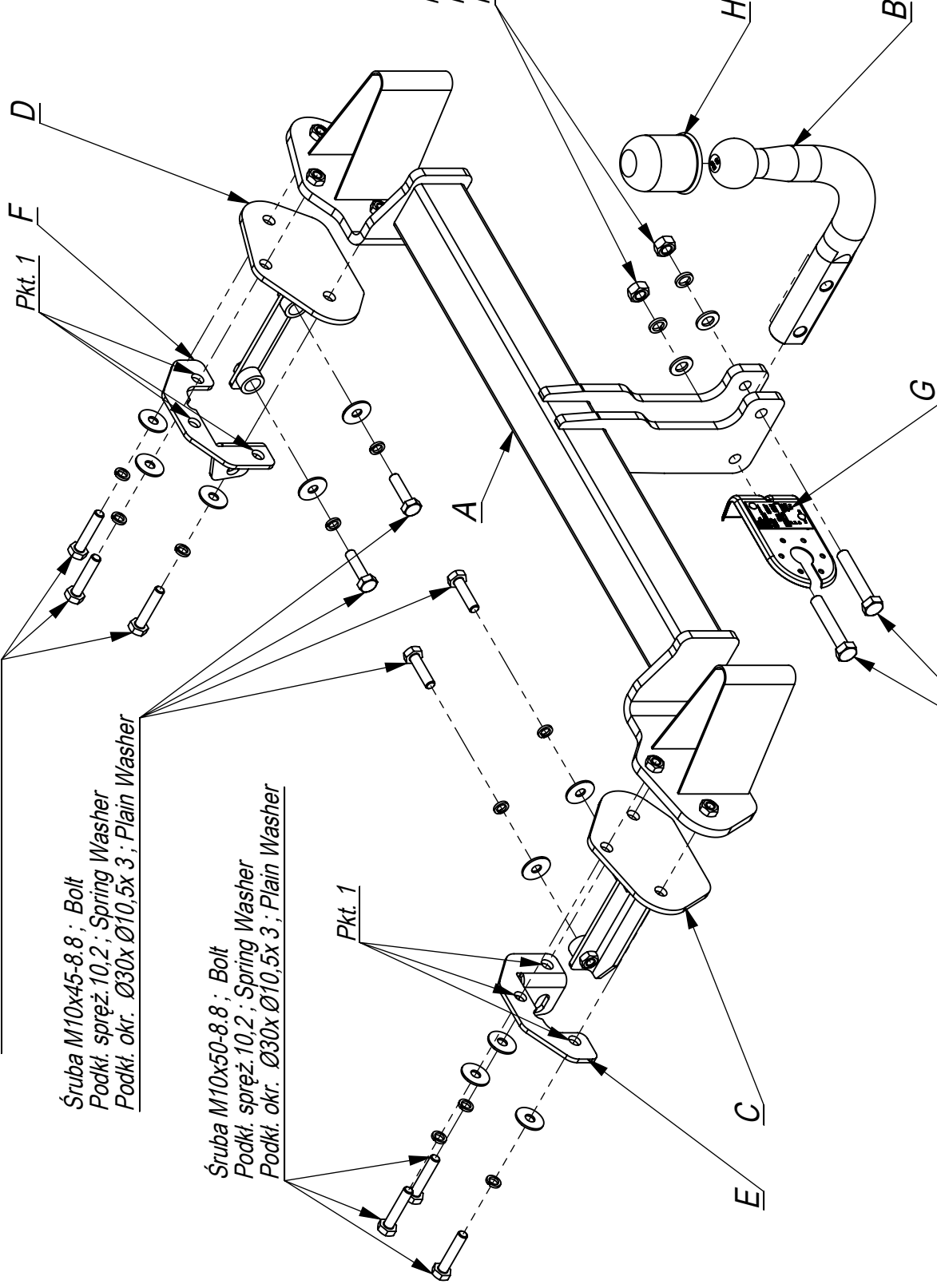

Nr katalogowy

B/007

Marka

BMW Seria 3 E46 Compact

od 06/01-05

BMW Seria 3 E46 4 D Coupe

od 04/98-05

- Odkręcić zderzak .
- W bagażniku zdemontować osłony tylnego pasa oraz podłogi.
- Odkręcić belkę zderzeniową
- Elementy D i C wsunąć w podłużnicę.
- Przyłożyć belkę haka A tak aby otwory pokrywały się z otworami w elementach D i C oraz z otworami w tylnym pasie.
- Przyłożyć do tylnego pasa od strony bagażnika elementy haka E i F i skręcić śrubami M10x50 8.8
- Elementy D i C przykręcić w bagażniku do boku podłużnic śrubami M10x45 8.8
- Przykręcić zderzak .
- Dokręcić kulę i podstawę gniazda elektrycznego.
- Podłączyć instalację elektryczną.
- Dokręcić wszystkie śruby z momentem wg tabeli.

- Unscrew the bumper.
- Disassemble the shields of the rear belt and oor in the boot.
- Unscrew the bumper bar.
- Insert the elements D and C in the metal clamps.
- Put the main bar A in this way, so the holes agree with the holes in the elements D and C and with the holes in the rear belt.
- Put the elements E and F to the rear belt from the side of the boot and screw with bolts M10x50 8.8.
- Screw the elements D and C to the side of the metal clamps in boot with bolts M10x45 8.8.
- Screw the bumper.
- Fix the ball and electric plate.
- Connect the electric wires.
- Tighten all the bolts according to the torque setting- see the table.

- Dévisser le pare-chocs.
- Démonter les protections de la bande postérieure et du plancher dans le core.
- Dévisser la poutre de chocs.
- Insérer les éléments D,C dans la longeron.
- Mettre la poutre du crochet d'attelage A pour que les trous soient adjacents aux trous dans les elements D et C et aux trous dans la bande postérieure.
- Mettre les éléments du crochet d'attelage E et F à la bande posterieure du côté du core et visser avec les boulons M10x50 8.8.
- Visser les éléments D et C dans le core aux bords des longerons avec les boulons M10x45 8.8.
- Poser le pare-chocs.
- Visser le crochet d'attelage et socle de prise électrique.
- Raccorder le circuit électrique.
- Serrer tous les boulons avec un couple de serrage selon tableau.

- Die Stoßstange abschrauben.
- Im Koerraum den hinteren Karosierestreifenschutz und den Boden demontieren.
- Den Stoßstange Balken abschrauben.
- Die Tragteile D und C in den Längsträger schieben.
- Den Querbalken A so anlegen, dass sich die Öffnungen mit den Elementen D und C und den Öffnungen im hinteren Stoßstangenstreifen decken.
- An den hinteren Karosierestreifen von der Seite des Koerraumes die Tragteile E und F anlegen und mit den Schrauben M10x50 8.8 verschrauben.
- Die Tragteile D und C im Koerraum an die Längsträgerseiten mit den Schrauben M10x45 8.8 anschrauben.
- Die Stoßstange anschrauben.
- Die Kugel und die Steckdosenhalterung anschrauben.
- Die Elektroinstallation anschließen.
- Alle Schrauben mit dem in der Tabelle angegebenen Drehmoment anschrauben.

- Desmontar el parachoques.
- En el maletero desmontar los resguardos de la banda trasera y del suelo.
- Desenroscar la barra de choques.
- Introducir los elementos D y C en el larguero.
- Poner la viga de la bola de remolque A de tal manera que los orificios coincidan con los orificios en los elementos D y C y con los orificios en la banda trasera.
- Poner los elementos de la bola de remolque E y F en la banda trasera, por el lado del maletero, y atornillarlos con tornillos M10x50 8.8.
- Atornillar los elementos D y C en el maletero al lateral de los largueros usando tornillos M10x45 8.8.
- Atornillar el parachoques.
- Atornillar la bola y el soporte de la toma de corriente.
- Conectar la instalación eléctrica.
- Apretar todos los tornillos con el par según la tabla anterior.

