



2010 -

CITROEN C-4 htb.

Cat. No. **C/033**

E20

E20 55R-01 3764

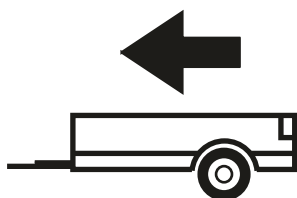

1500kg

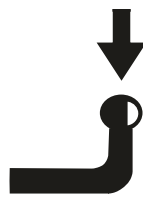

66kg

D=8,05kN

D (kN) =



MAX kg

x

MAX kg

x 0,00981



MAX kg

+

MAX kg



IMIOLA HAK-POL

96-111 KOWIESY, CHOJNATA 23A, POLAND

Tel. + 48 46 831 73 31, fax +48 831 74 29

e-mail: office@imiola.pl, www.imiola.pl

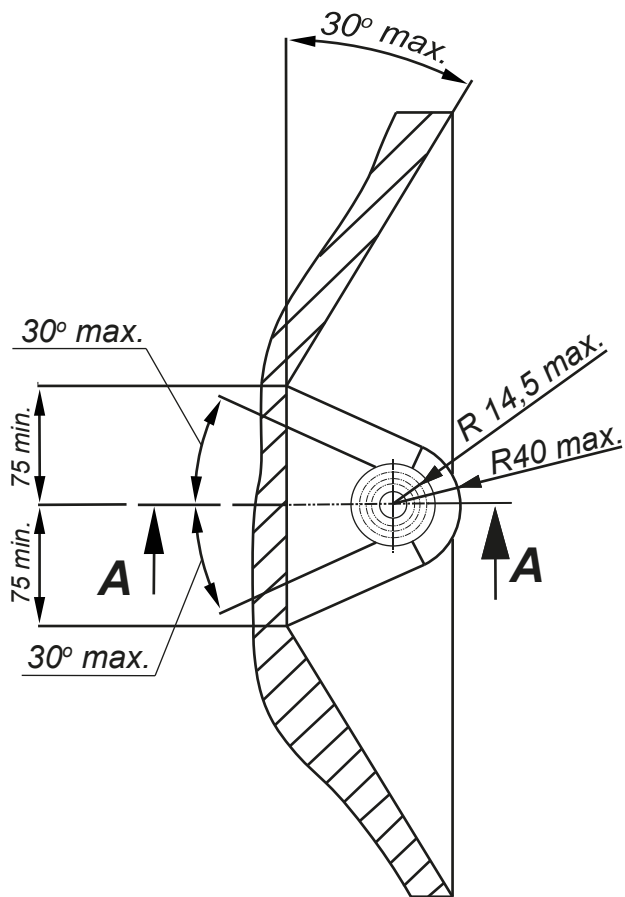

PRZEKRÓJ A-A

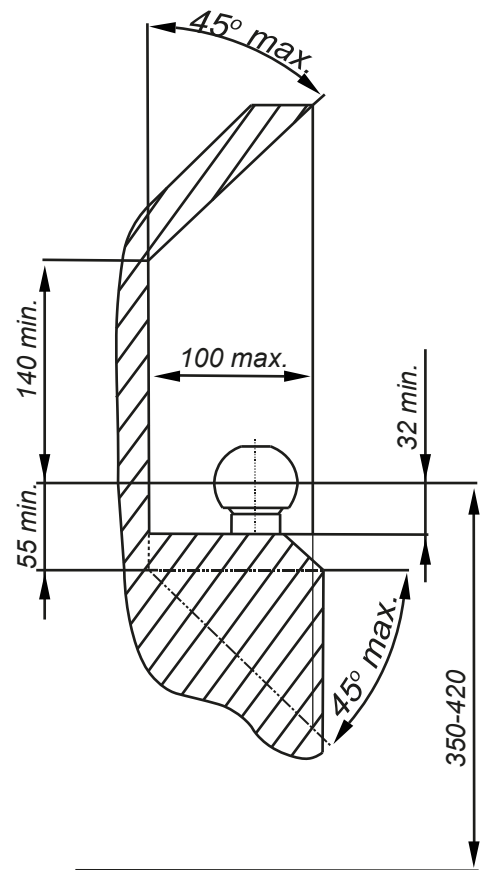

PL Należy zagwarantować przestrzeń swobodną według załącznika VII, rysunek 25a/b Regulaminu EKG ONZ 55.01 przy dopuszczalnym ciężarze całkowitym pojazdu.

F L'espace libre doit être garanti conformément à l'annexe VII, illustration de la réglementation 55.01 CE pour un poids total en charge autorisé du véhicule.







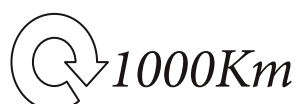

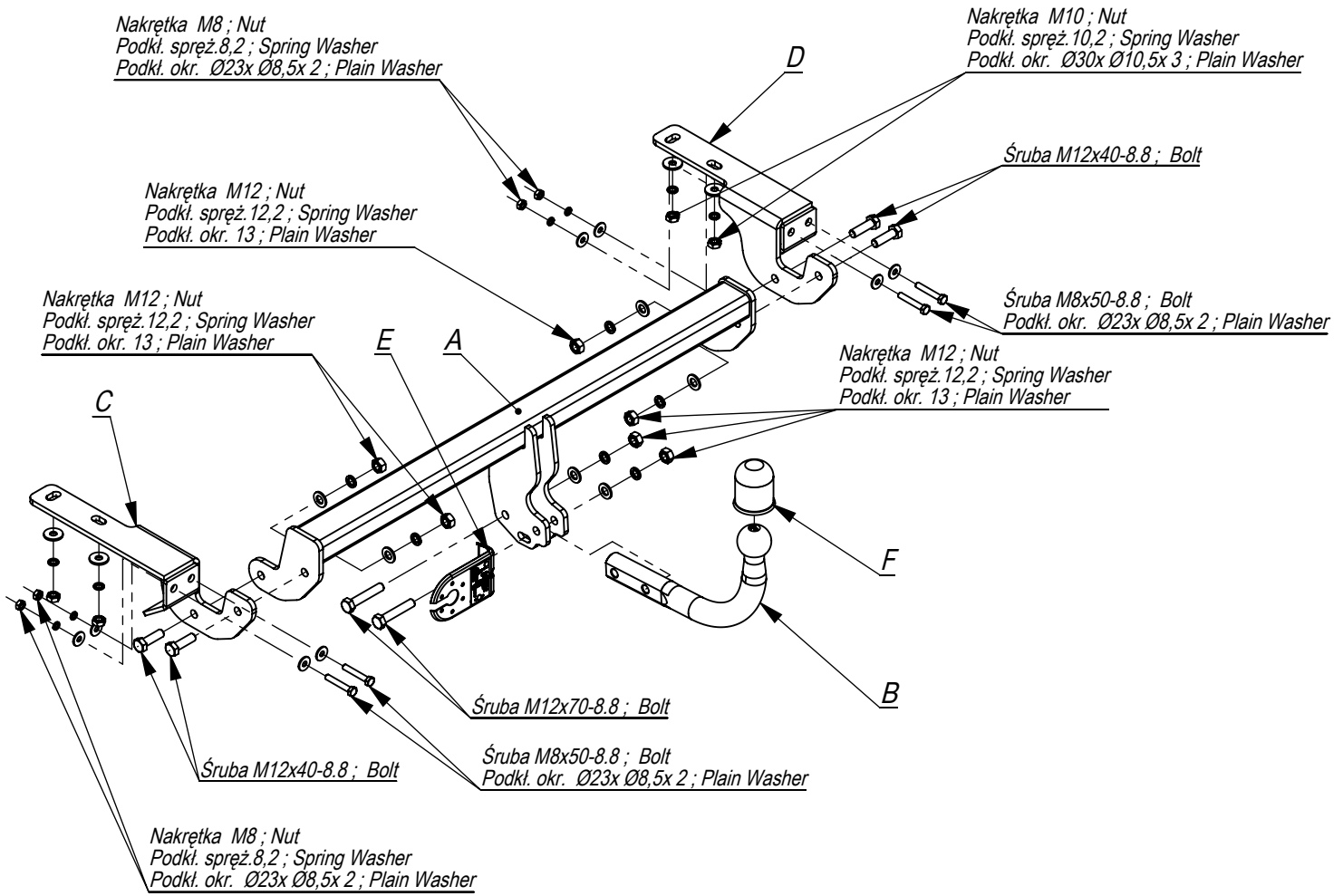
GB The clearance specified in appendix VII, diagram 25a/b of Regulation No. 55.01 UN EU must be guaranteed at laden weight of the vehicle.

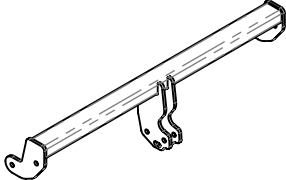
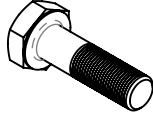
D Der Freiraum nach Anhang VII, Abbildung 25a/b der Vorschriften 55.01 EG ist zu gew 25a/b abzuwehren bei zulässigem Gesamtgewicht des Fahrzeuges.

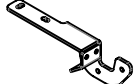
Moment skręcający dla śrub i nakrętek (8.8) Torque settings for nuts and bolts (8.8)	
M8	25Nm
M10	55Nm
M12	85Nm
M14	135Nm
M16	195Nm





	A	x1		M12x70	2
				M12x40	4
				M8x50	4
	B	x1		M12	6
				M10	4
				M8	4
	C	x1		Ø30xØ10,5x3	4
				Ø23xØ8,5x2	8
	D	x1		13	6
	E	x1		12,2	6
				10,2	4
				8,2	4
	F	x1			

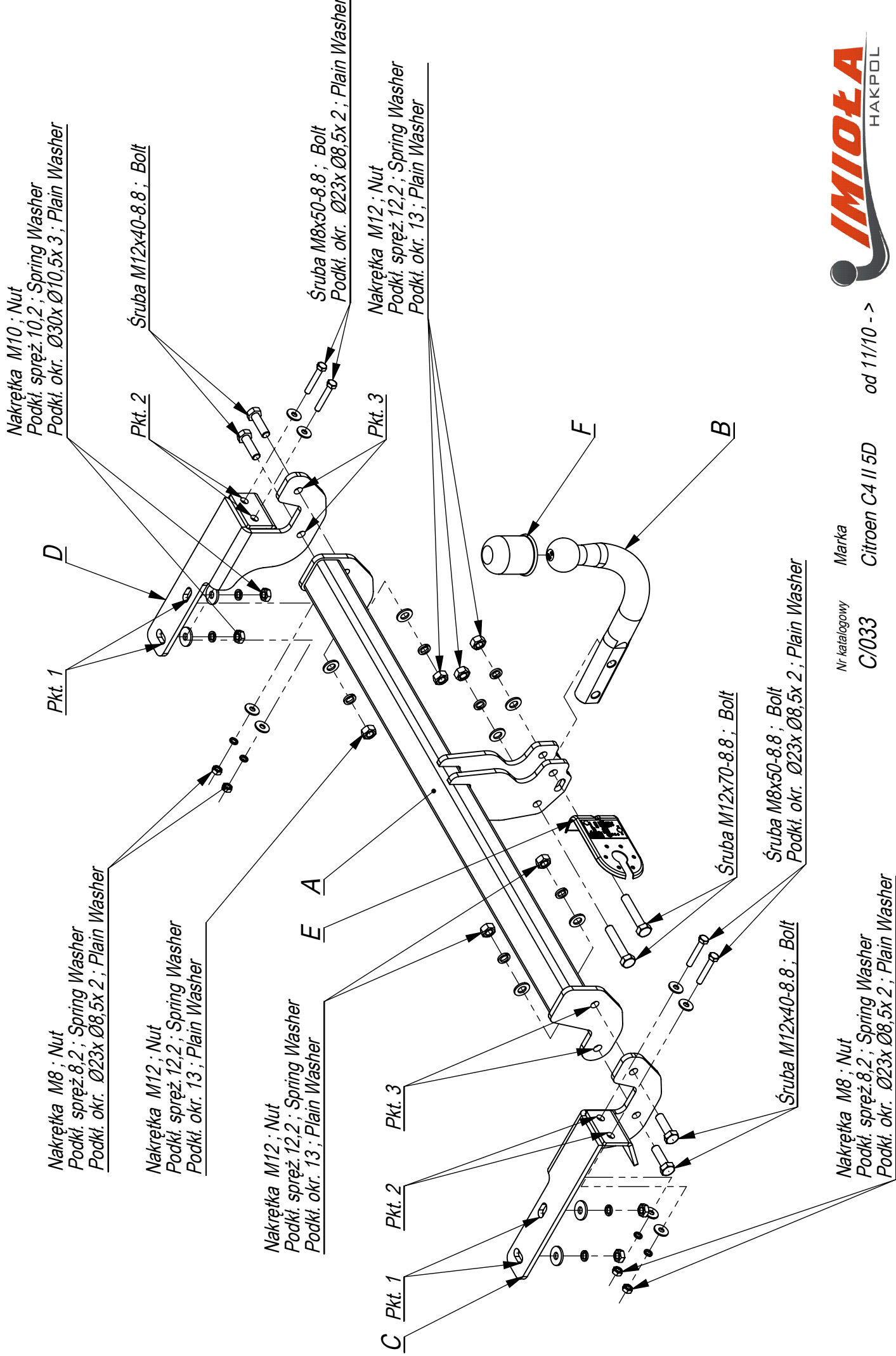

- Odkręcić śruby mocujące zderzak od spodu.
- Wyciąć w dolnej części zderzaka, w jego osi fragment 35x50.
- Elementy C i D przyłożyć od spodu do podłużnic i poprzez technologiczne śruby przykręcić lekko oraz śrubami M8x50 8.8.
- Belkę haka A wsunąć między elementy i przykręcić śrubami M12x40 8.8.
- Dokręcić wszystkie śruby z momentem według tabeli.
- Dokręcić kulę i blachę gniazda elektrycznego.
- Podłączyć instalację elektryczną.

- Unscrew the bumper fitting bolts from the bottom.
- Cut out the fragment 35x50 in the lower part of the bumper, in its axle.
- Put the elements C and D from the bottom to the frame side members and screw slightly with the technological nuts and bolts M8x50 8.8.
- Insert the main bar A between the elements and screw with bolts M12x40 8.8.
- Tighten all the bolts according to the torque setting- see the table.
- Fix the ball and electric plate.
- Connect the electric wires.

- Dévisser les vis xant le pare chocs du bas.
- Ouvrir la partie basse de pare-chocs de 35x50.
- Inler les éléments C et D du bas des longerons et légèrement serrer avec les écrous originaux et les vis M8x50 8.8.
- Inserer la poutre du crochet A entre les éléments et serrer avec les boulons M12x40 8.8.
- Serrer tous les boulons avec un couple de serrage selon tableau.
- Visser la boule et la tôle de la prise électrique.
- Raccorder le circuit électrique.

- Die Stoßstange von unten befestigenden Schrauben abschrauben.
- Im unten Teil der Stoßstange ein Stück in ihrer Achse 35x50 ausschneiden.
- Die Tragteile C und D von unten an die Längsträger anlegen und durch die vom Werk aus vorhandenen Öffnungen mit den Schrauben M8x50 8.8 locker anschrauben.
- Den Querbalken A zwischen die Tragteile schieben und mit den Schrauben M12x40 8.8 verschrauben.
- Alle Schrauben mit dem in der Tabelle angegebenen Drehmoment festziehen.
- Die Kugel und die Steckdosenhalterung anschrauben.
- Die Elektroinstallation anschließen.

- Fije ligeramente las partes C y D a la parte inferior del automóvil con tornillos M8x50 8.8
- Aplique el gancho A a los elementos y apriéte los con pernos M12x40 8.8
- Hacer un corte en el parachoques para las garras de la bola.
- Apriete todos los pernos de acuerdo con la tabla.
- Apriete la bola y la placa del enchufe eléctrico.
- Conecte la instalación eléctrica

