

Chevrolet Matiz M200 2005-

Partnr.: CH-002-DL

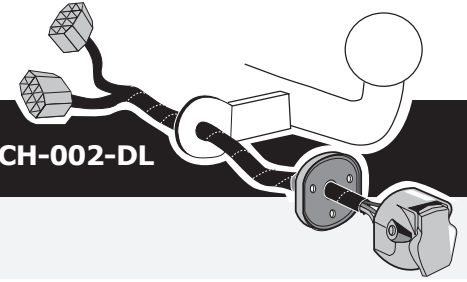

DU	Einbauanleitung Elektrosatz Anhängervorrichtung mit 12-N Steckdose It. DIN/ISO Norm 1724.	CZ	Montážní pokyny: souprava pro elektrické propojení tažné tyče s 12 - N zásuvkou do normy DIN/ISO 1724.
FR	Instructions de montage du faisceau électrique pour crochet d'attelage conforme à la norme DIN/ISO 1724 prise 12-N	DK	Monteringsvejledning for det elektriske ledningsføringssæt for trækstang med 12-N stikdåse, DIN/ISO, norm 1724.
NL	Montage-handleiding elektrokabelset voor trekhaak met 12-N contactdoos vlg. DIN/ISO norm 1724.	FI	Ohjeet vetokoukun sähkökaapelisarjan asentamiseen, jossa on DIN/ISO 1724 mukainen 12-N liitin.
GB	Fitting instructions electric wiring kit tow bar with 12-N socket up to DIN/ISO Norm 1724.	GR	Οδηγίες συναρμολόγησης ηλεκτρικού σετ καλωδίων μπάρας ρυμούλκησης με υποδοχή 12-N μέχρι DIN/ISO Κανόνας 1724.
ES	Instrucciones de montaje de kit eléctrico para enganche de remolque con caja de conexiones 12-N según norma DIN/ISO 1724.	NO	Monteringsanviser elkabelsett for trekrok med 12-N koblingsboks ifølge DIN/ISO norm 1724.
IT	Istruzioni di montaggio di set di cavi elettrici per gancio da traino con zoccolo a 12 N conforme alla norma DIN/ISO 1724.	PL	Instrukcje montażu zestawu okablowania elektrycznego dyszla holowniczego z 12-N stykowym gniazdem DIN/ISO 1724.
SE	Monteringsanvisningar elkabelsats för dragkrok med 12-N kontaktdosa enligt DIN/ISO norm 1724.		

DU	- Wir weisen ausdrücklich darauf hin, dass eine unsachgemäße und nicht in einer Fachwerkstatt durchgeführte Montage einen Verzicht auf Entschädigung jeglicher Art insbesondere bezüglich des Produkthaftpflichtrechts zur Folge hat.	- Technische Änderungen vorbehalten. - Widerstand nur gemäß der Tabelle auf dem Anhänger verwenden, siehe Seite 10.
FR	- Il est expressément prévu qu' on ne saurait se prévaloir d'un quelconque préjudice contractuel ou rédhibitoire si le montage avait été fait en dépit des dites instructions ou dans un garage ne disposant pas des équipements adéquats.	- Sous réserve de modifications techniques. - Ne excédez pas la charge maximale, indiquée dans le tableau sur page 10.
NL	- Wij wijzen er met nadruk op, dat ondeskundige en niet door een vakkundige werkplaats uitgevoerde montage tot gevolg heeft dat daardoor ieder recht op schadevergoeding, ook op wettelijke aansprakelijkheid inzake producten, vervalt.	- Technische wijzigingen voorbehouden. - Gebruik alleen belasting volgens aansluittabel op het getrokken voertuig, zie pagina 10.
GB	- We would expressly point out that any improper assembly which is not carried out in a specialist workshop will result in the renunciation of the enforcement of compensation claims of any kind, in particular those arising by virtue of the product liability law.	- Subject to alteration without notice. - Only use maximum charge according to connection table on towed vehicle, see page 10.
ES	- El montaje inapropiado y efectuado por personal no cualificado originará la pérdida de todo derecho a indemnización o la expiración de toda responsabilidad civil con respecto al producto.	- Nos reservamos el derecho a efectuar modificaciones técnicas. - Utilice sólo cargas de acuerdo a la tabla de conexión del vehículo remolcado (ver página 10).
IT	- Sottolineiamo espressamente che un montaggio inadeguato ed eseguito da un'officina non specializzata ha come conseguenza il decadere di qualsiasi diritto al risarcimento danni, nonché alla responsabilità legale relativa ai prodotti.	- Ci si riserva il diritto di apportare modifiche tecniche. - Utilizzare esclusivamente un carico conforme alla tabella degli allacci relativa al veicolo in questione, cfr. pagina 10.
SE	- Vi påpekar med eftertryck att all rätt till skadeersättning och all laglig ansvarighet förfaller om monteringen inte har utförts på rätt sätt och av en professionell verkstad.	- Tekniska ändringar förbehålles. - Använd endast belastning enligt anslutningstabellen på det dragna fordonet, se sid. 10.
CZ	- Výslovně zdůrazňujeme, že jakákoli montáž, která není provedená ve specializované dílně, má za následek odvolání nároků na kompenzaci jakéhokoliv druhu, obzvláště vyplývajících ze zákona o odpovědnosti za způsobené škody.	- Změny mohou být provedeny bez oznámení. - Používejte pouze při maximálním nabití podle tabulky na tažném vozidle, viz. str. 10.
DK	- Vi ønsker at gøre udtrykkeligt opmærksom på at forkert samling, der ikke er udført af et specialiseret værksted, resulterer i bortfaldelse af kompenseringskrav af alle slags, i særdeles krav der måtte opstå omkring det lovpligtige ansvar.	- Kan ændres uden varsel. - Brug kun den maksimale belastning, i overensstemmelse med forbindelsestabelen for bugserede køretøjer, side 10.
FI	- Korostamme, että kaikki oikeudet vahinkokorvaukseen kuten myös valmistajan laillinen vastuu raukeavat, mikäli asennusta ei ole toteutettu oikealla tavalla eikä ammattitaitoisen asiantuntijan toimesta.	- Oikeus teknisiin muutoksiin ilman erillistä huomautusta pidetään. - Kuormita työvirtapiiriä ainoastaan hinattavan ajoneuvon kytkentäkaavion mukaisesti, katso sivu 10.
GR	- Επισημαίνουμε κατηγορηματικά ότι οποιαδήποτε εσφαλμένη συναρμολόγηση, η οποία δεν έχει πραγματοποιηθεί ειδικό εργαστήριο θα οδηγήσει σε απονομή των αξιώσεων επιβολής αποζημιώσεων οποιαδήποτε είδους, ειδικά όσα προκύπτουν από το νόμο ευθύνης προϊόντων.	- Μπορεί να τροποποιηθεί χωρίς προηγούμενη ειδοποίηση. - Χρησιμοποιείτε μόνο μέγιστο ηλεκτρικό φορτίο σύμφωνα με τον πίνακα σύνδεσης στο ρυμούλκούμενο όχημα, δείτε σελίδα 10.
NO	- Vi påpeker ettertrykkelig at all rett til skadeerstatning og rettslig ansvar forfaller dersom monteringen ikke er blitt utført på riktig måte og av et profesjonelt verksted.	- Tekniske endringer forbeholdes. - Overskrid ikke grensene anvist i tilkoblingstabellen på tilhengeren eller det tilkoblede kjøretøyet, se s. 10.
PL	- Chcielibyśmy wyraźnie zaznaczyć, iż wszelki nieprawidłowy montaż, który nie jest wykonywany w specjalistycznym warsztacie pociąga za sobą utratę możliwości dochodzenia wszelkiego typu roszczeń, w szczególności tych wynikających z odpowiedzialności producenta za swój produkt.	- Podlega zmianom bez powiadomienia. - Używać tylko takiego maksymalnego obciążenia które wynika z tabliczki połączeń holowanego pojazdu, patrz strona 10.

Einzelteilliste

Liste de pieces

Onderdelenlijst

Part list

Lista de componentes

Elenco componenti

Dellista

Seznam dílů

Del-liste

Osaluettelo

Κατάλογος εξαρτημάτων

Delliste

Lista części

(DU)

(FR)

(NL)

(GB)

(ES)

(IT)

(SE)

(CZ)

(DK)

(FI)

(GR)

(NO)

(PL)

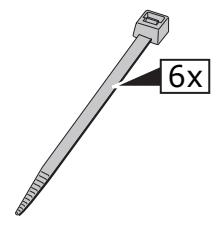
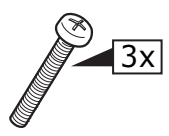
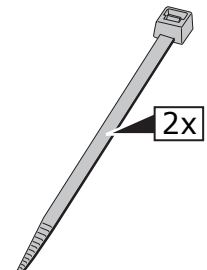
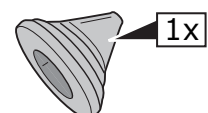
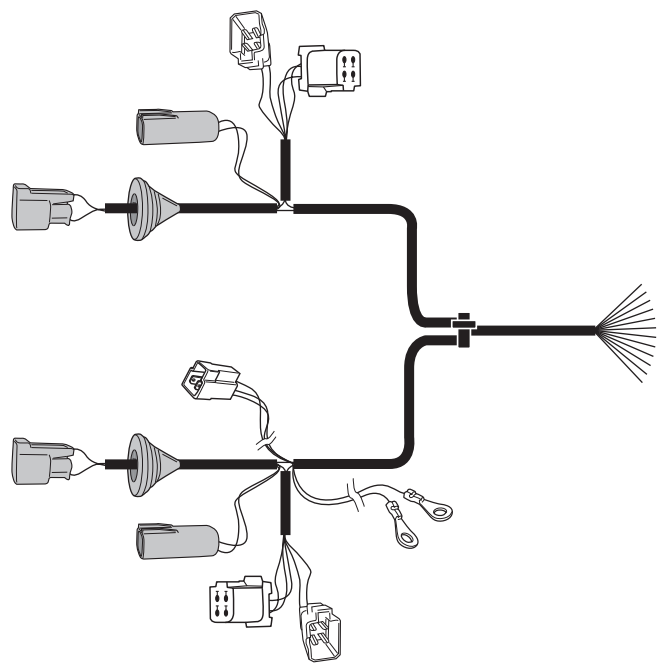
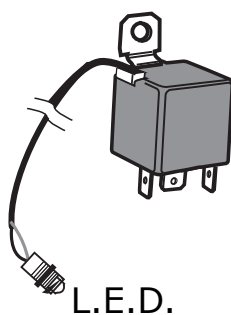
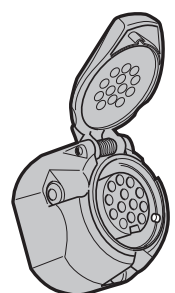
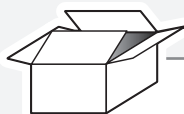

1

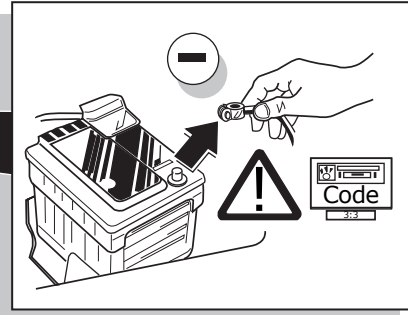
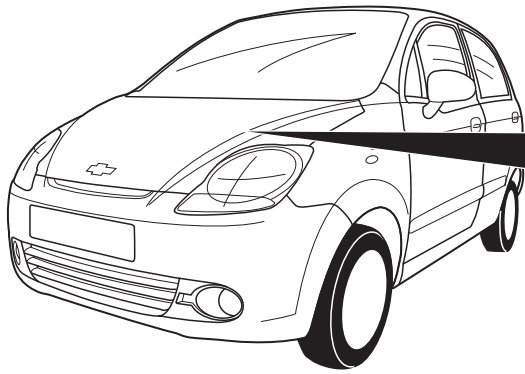

2

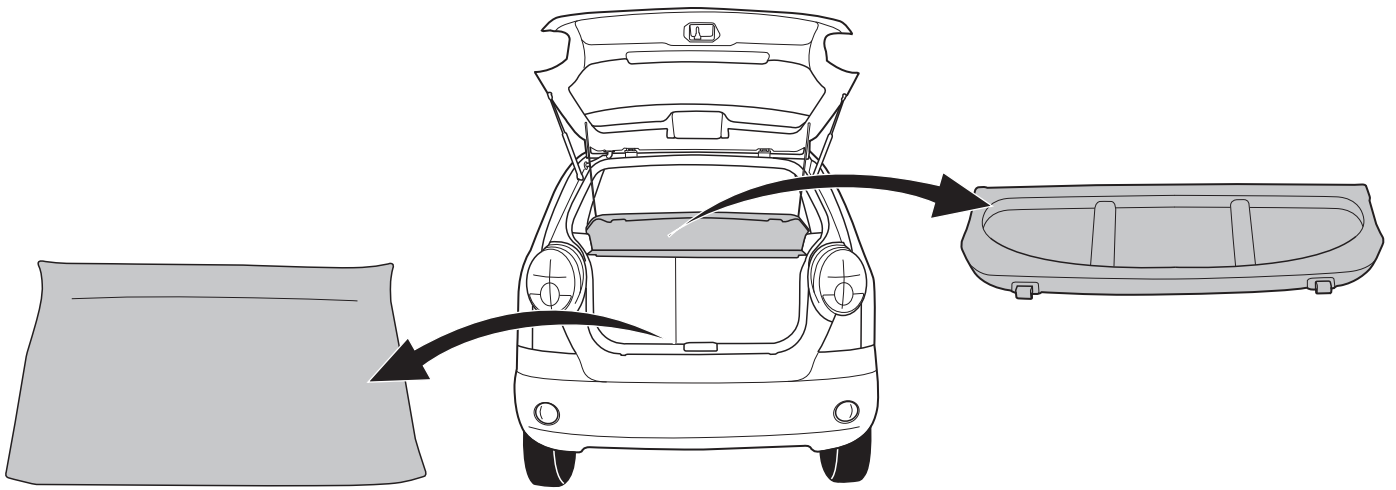

3

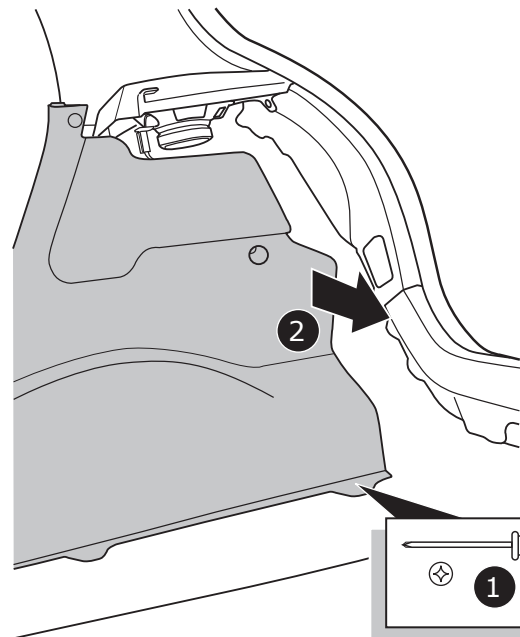
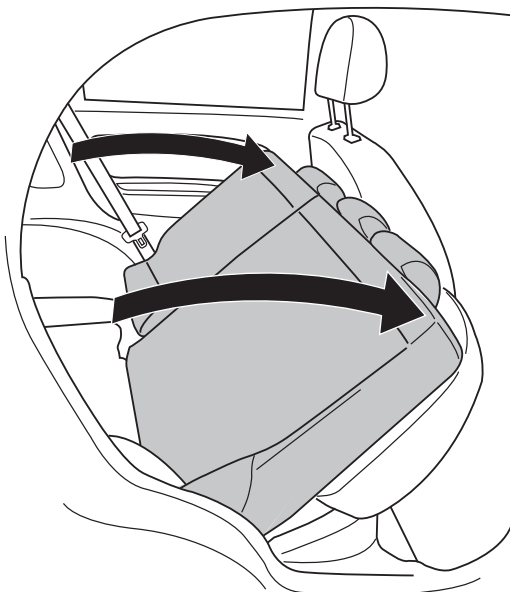

INFO

- (DU) Vorbereitete Steckverbindung für zusätzliche Spannung.
- (FR) Connecteur préparé pour extra alimentation continue.
- (NL) Voorbereide connector voor extra spanning.
- (GB) Prepared connector for extra power supply.
- (ES) Conector listo para tensión adicional.
- (IT) Prepara connettore per tensione extra.
- (SE) Förberedd kontakt för extra spänning.
- (CZ) Připravte konektor pro přídatný zdroj proudu.
- (DK) Klargjort konnektor for ekstra strømforstyrning.
- (FI) Esiasennettu lisäjänniteliitin.
- (GR) Έτοιμος ρευματολήπτης για επιπλέον παροχή ρεύματος.
- (NO) Forberedet kontakt for ekstra spenning.
- (PL) Przygotowane złącze do dodatkowego zasilania.

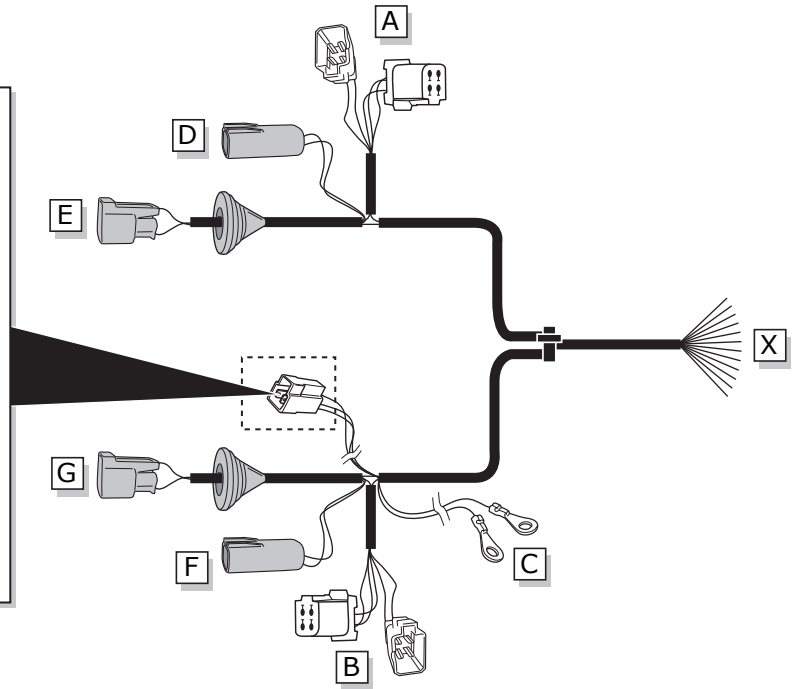

ROUTING

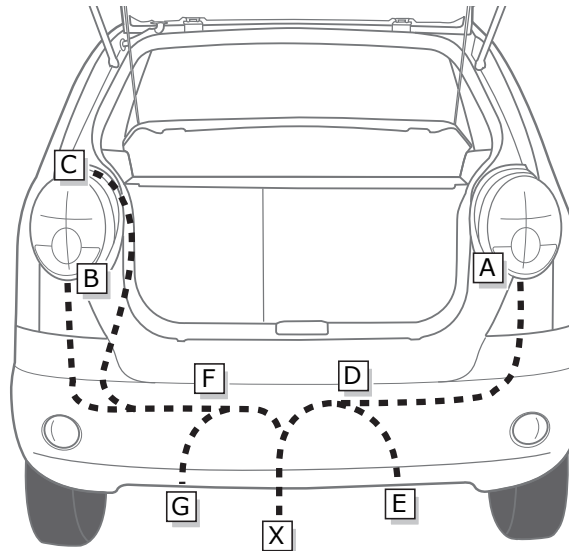

4

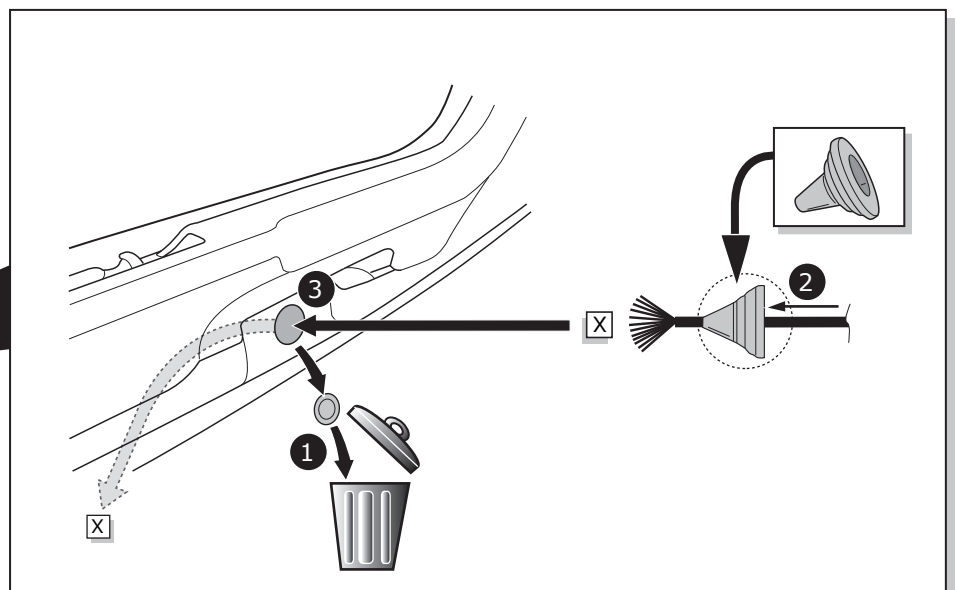
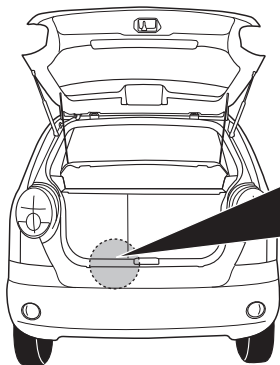

5

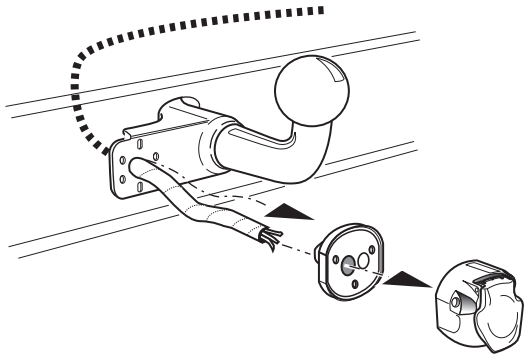

6

- Ⓧ(DU) Anschluss Steckdose
- Ⓧ(FR) Connection de la prise
- Ⓧ(NL) Contactdoos aansluiting
- Ⓧ(GB) Socket connection
- Ⓧ(ES) Conexión de la caja de enchufe
- Ⓧ(IT) Allaccio zoccolo
- Ⓧ(SE) Anslutning kontaktdosa
- Ⓧ(CZ) Objímkový konektor
- Ⓧ(DK) Stikdåse forbindelse
- Ⓧ(FI) Pistorasia liitäntä
- Ⓧ(GR) Υποδοχή σύνδεσης
- Ⓧ(NO) Tilkobling koblingsboks
- Ⓧ(PL) Połączenie przez gniazdo



Pag. 10

INFO

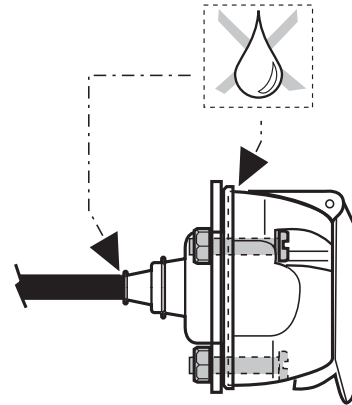
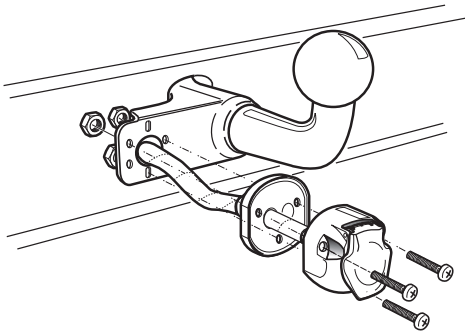

7

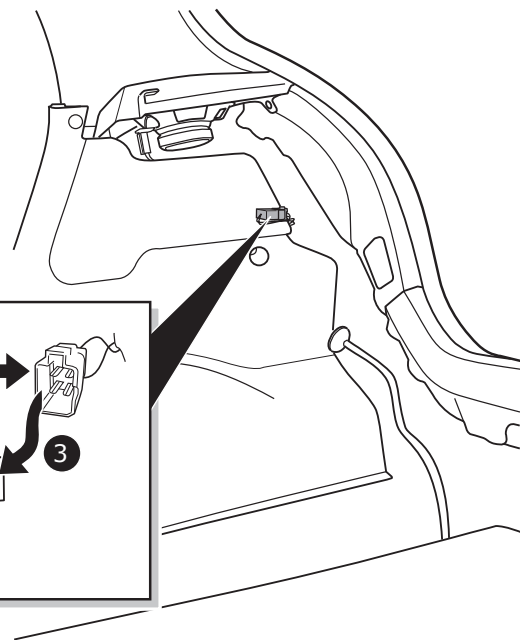
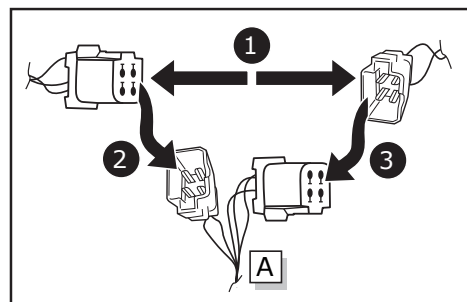
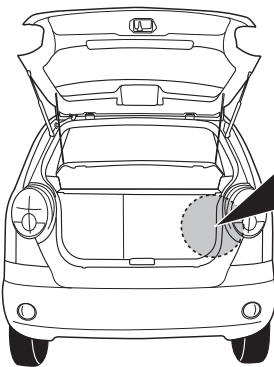

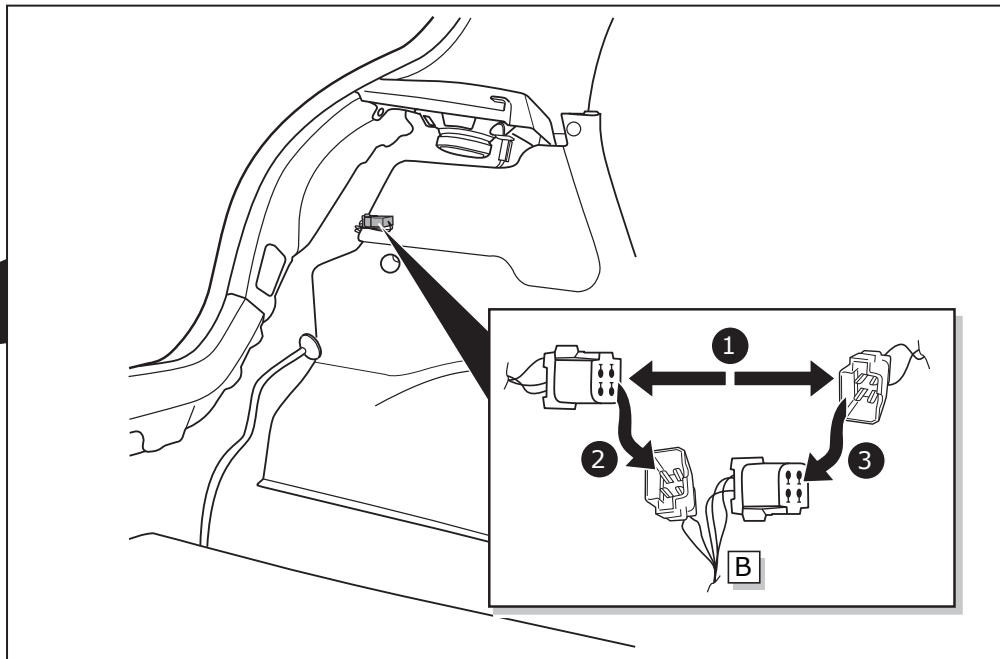
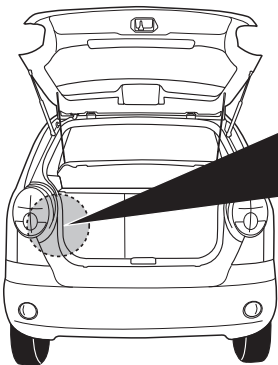
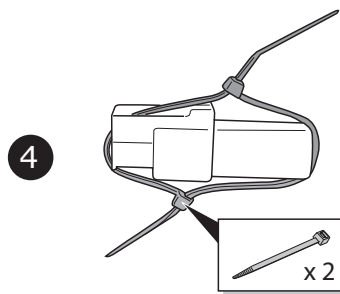
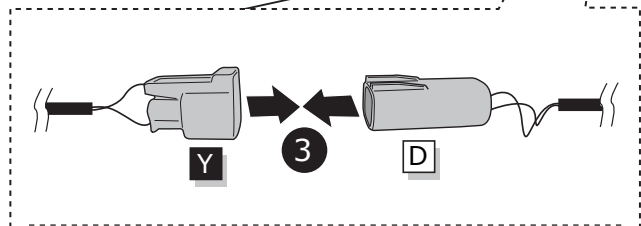
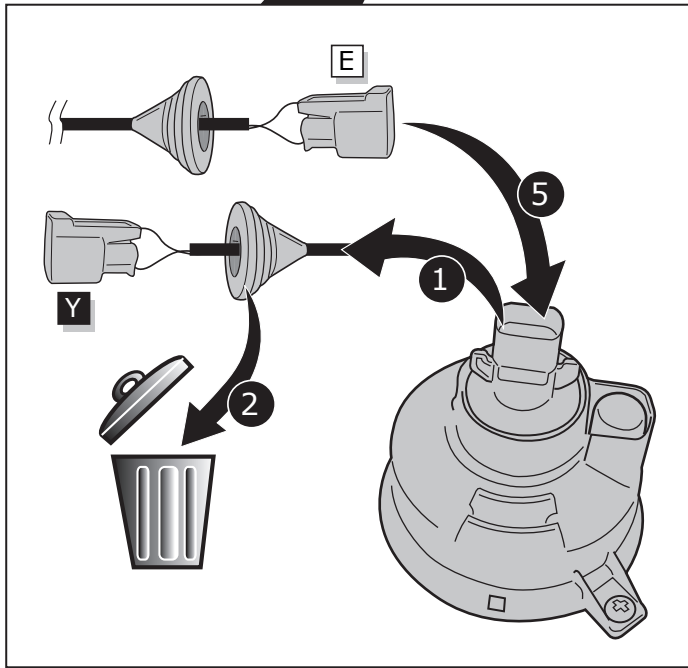
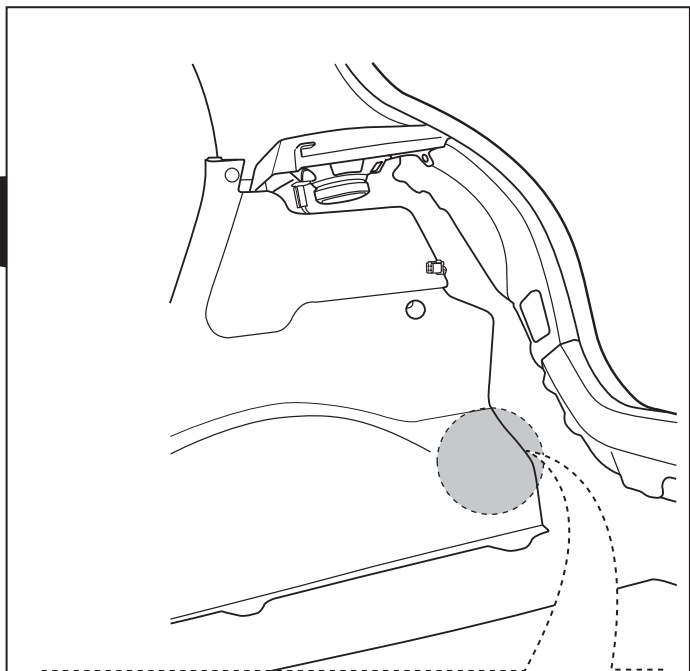
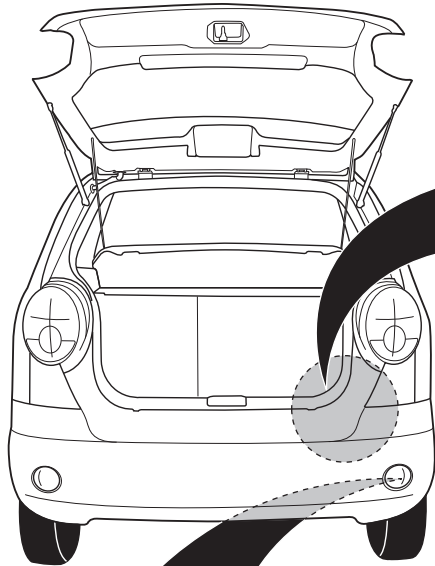

10

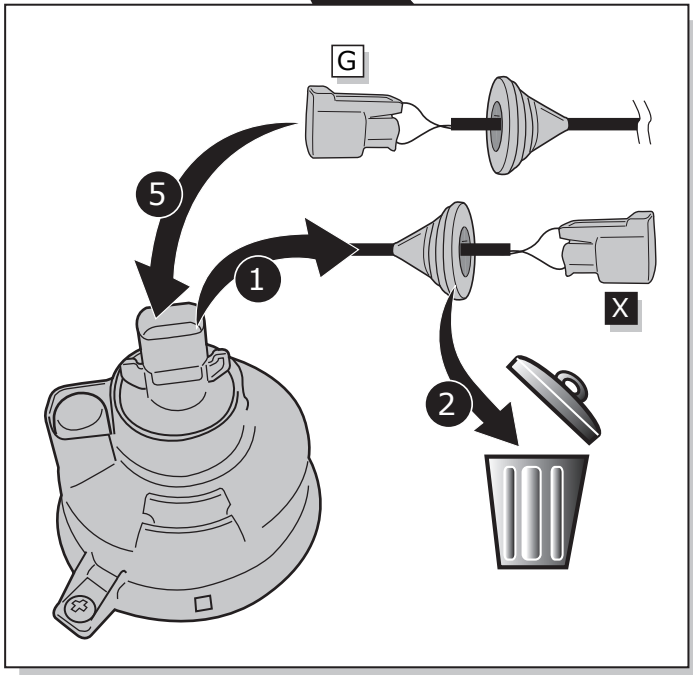
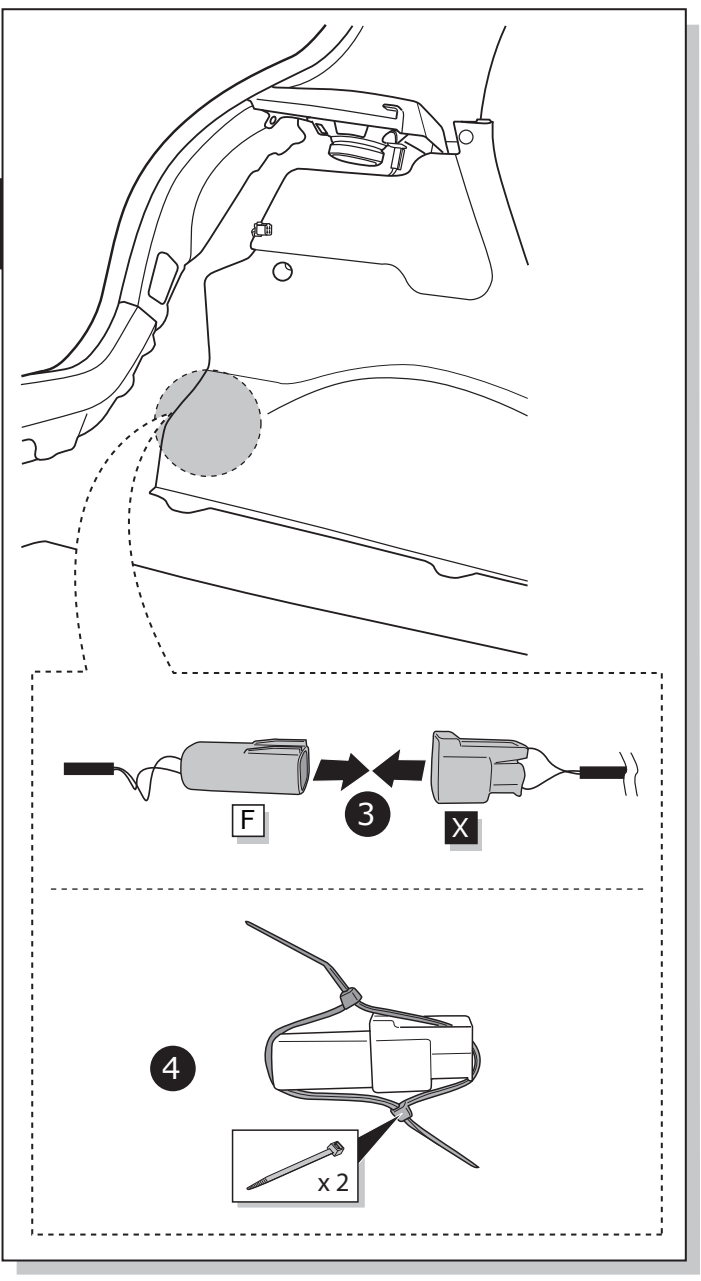
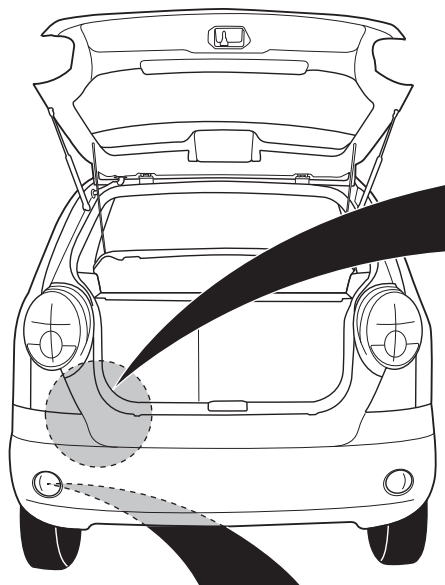

11

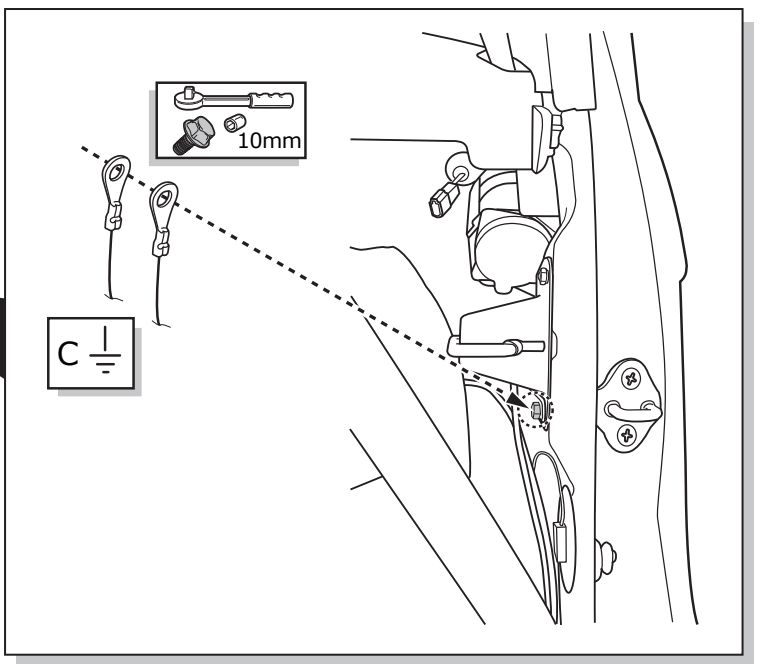
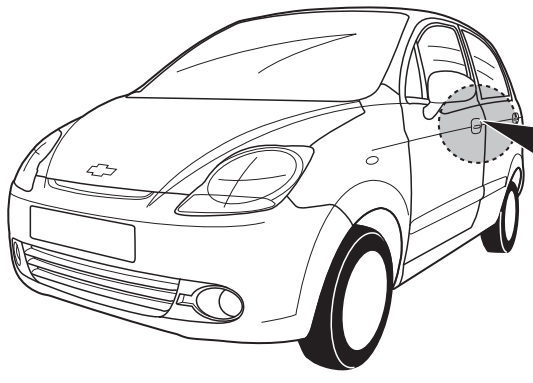

12

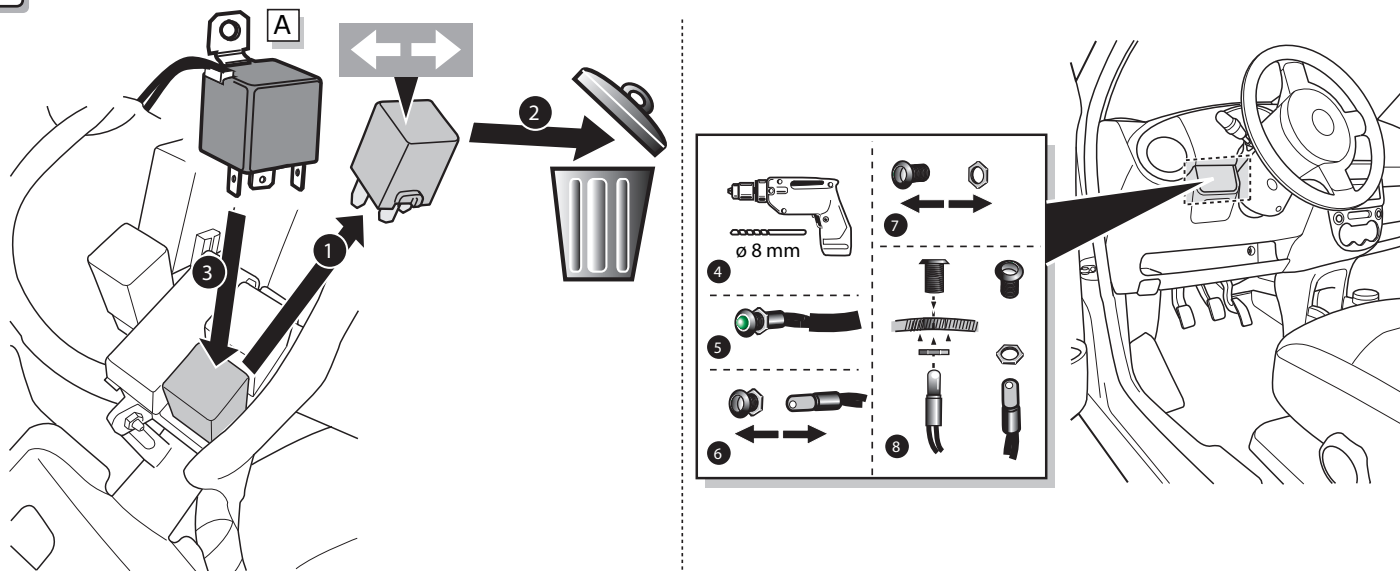

13

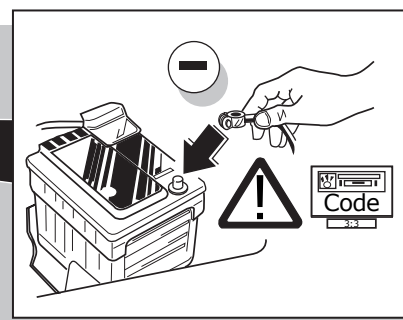
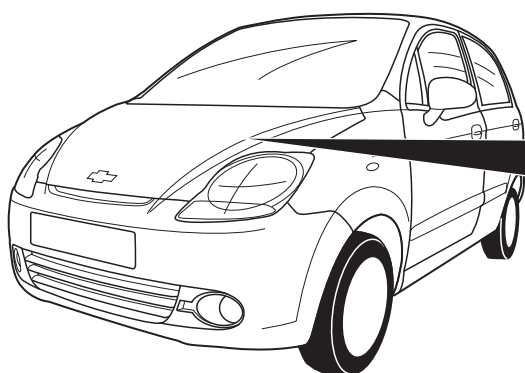

14



(DU) FUNKTIONEN KONTROLLIEREN!

(FR) CONTRÔLER LES FONCTIONS!

(NL) CONTROLEER FUNCTIES!

(GB) CHECK FUNCTIONS!

(ES) ¡CONTROLAR FUNCIONES!

(IT) CONTROLLA FUNZIONI!

(SE) KONTROLLERA FUNKTIONERNA!

(CZ) OVĚŘTE FUNKCE!

(DK) CHECK FUNKTIONERNE!

(FI) TARKISTA TOIMINNOT!

(GR) ΕΛΕΓΉΤΕ ΤΙΣ ΛΕΙΤΟΥΡΓΙΕΣ!

(NO) KONTROLER FUNKSJONENE!

(PL) SPRAWDŹ FUNKCJE!



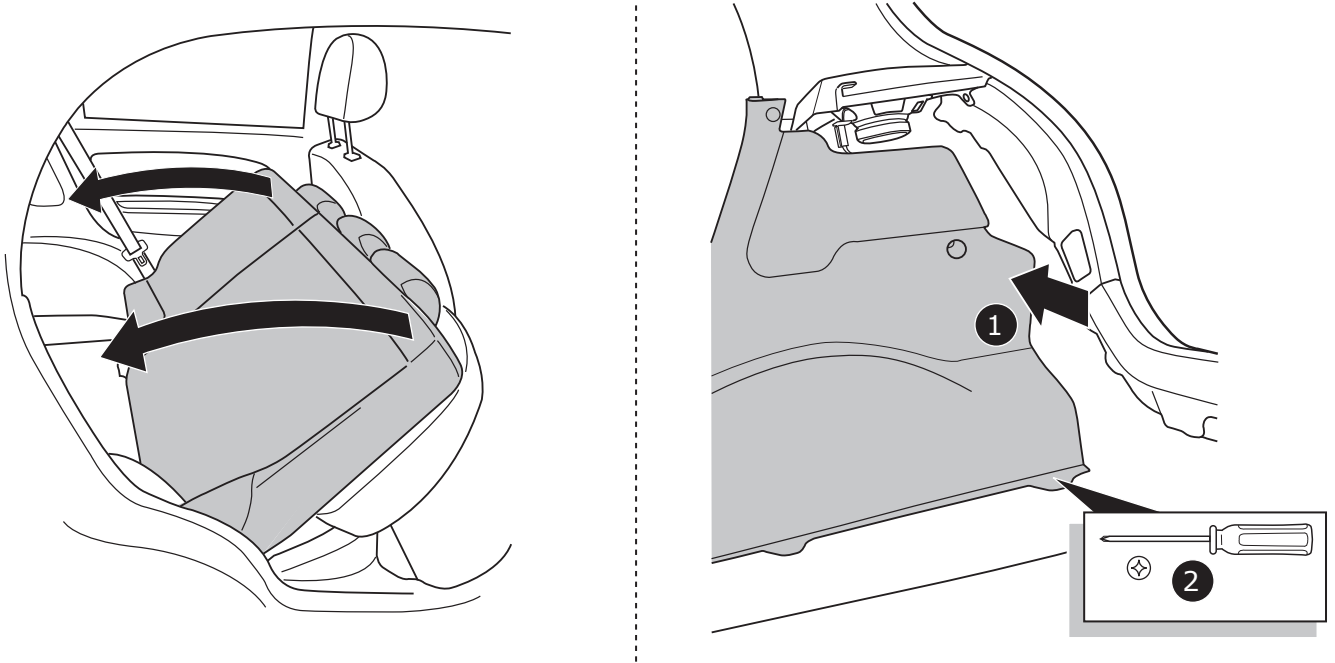



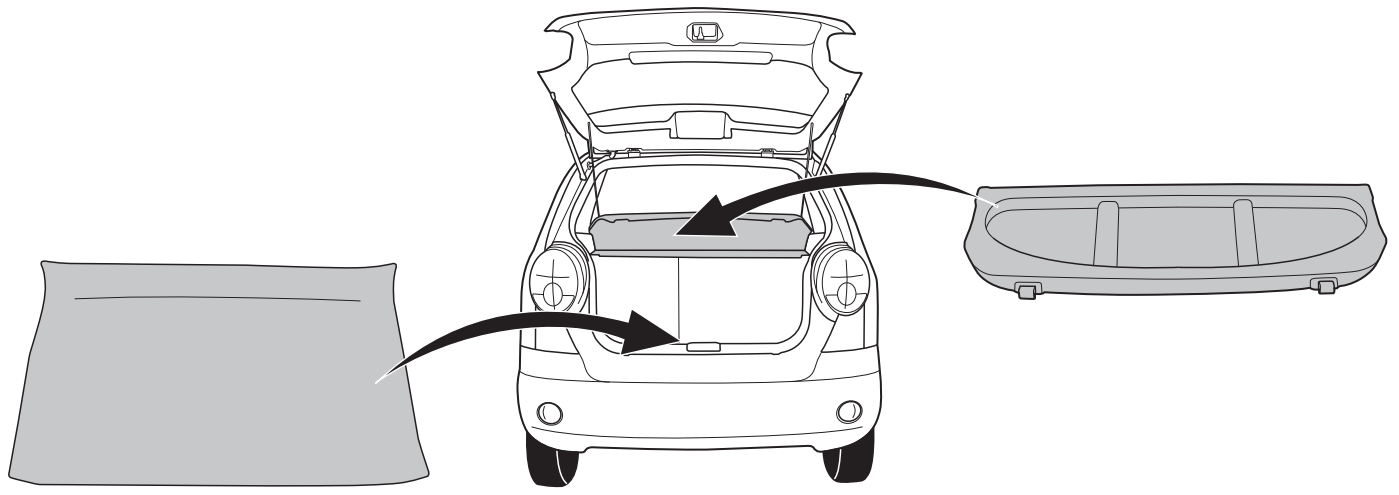



15



16



- (DU) Anschluss Steckdose
 (FR) Connection de la prise
 (NL) Contactdoos aansluiting
 (GB) Socket connection
- (ES) Conexión de la caja de enchufe
 (IT) Allaccio zoccolo
 (SE) Anslutning kontaktdosa
- (CZ) Objímkový konektor
 (DK) Stikdåse forbindelse
 (FI) Pistorasia liitäntä
- (GR) Υποδοχή σύνδεσης
 (NO) Tilkobling koblingsboks
 (PL) Połączenie przez gniazdo

DIN/ISO 11446				$\frac{1}{1-8}$								$\frac{1}{10}$	$\frac{1}{9}$
Pmax	1/L	2	2a	3/31	4/R	5/58-R	6/54	7/58-L	8	9	10	11	12
	21W	2x21W		21W		52W	3x21W	52W	2x21W	180W/15Amp.	180W/15Amp.		
(DU)	Gelb	Blau	Grau	Weiß	Grün	Braun	Rot (1,00mm)	Schwarz	Schwarz/ Rot	Braun/ Weiß	Rot (2,50mm)	Weiß	Weiß
(FR)	Jaune	Bleu	Gris	Blanc	Vert	Marron	Rouge (1,00mm)	Noir	Noir/ Rouge	Marron/ Blanc	Rouge (2,50mm)	Blanc	Blanc
(NL)	Geel	Blauw	Grijs	Wit	Groen	Bruin	Rood (1,00mm)	Zwart	Zwart/ Rood	Bruin/ Wit	Rood (2,50mm)	Wit	Wit
(GB)	Yellow	Blue	Grey	White	Green	Brown	Red (1,00mm)	Black	Black/ Red	Brown/ White	Red (2,50mm)	White	White
(ES)	Amarillo	Azul	Gris	Blanco	Verde	Marrón	Rojo (1,00mm)	Negro	Negro/ Rojo	Marrón/ Blanco	Rojo (2,50mm)	Blanco	Blanco
(IT)	Giallo	Blu	Grigio	Bianco	Verde	Marrone	Rosso (1,00mm)	Nero	Nero/ Rosso	Marrone/ Bianco	Rosso (2,50mm)	Bianco	Bianco
(SE)	Gul	Blå	Grå	Vit	Grön	Brun	Röd (1,00mm)	Svart	Svart/ Röd	Brun/ Vit	Röd (2,50mm)	Vit	Vit
(CZ)	Žlutá	Modrá	Šedá	Bílá	Zelená	Hnědá	Červená (1,00mm)	Černá	Černá/ Červená	Hnědá/ Bílá	Červená (2,50mm)	Bílá	Bílá
(DK)	Gul	Blå	Grå	Hvid	Grøn	Brun	Rød (1,00mm)	Sort	Sort/ Rød	Brun/ Hvid	Rød (2,50mm)	Hvid	Hvid
(FI)	Keltainen	Sininen	Harmaa	Valkoinen	Vihreä	Ruskea	Punainen (1,00mm)	Musta	Musta/ Punainen	Ruskea/ Valkoinen	Punainen (2,50mm)	Valkoinen	Valkoinen
(GR)	Κίτρινο	Μπλε	Γκρι	Λευκό	Πράσινο	Καφέ	Κόκκινο (1,00mm)	Μαύρο	Μαύρο/ Κόκκινο	Καφέ/ Λευκό	Κόκκινο (2,50mm)	Λευκό	Λευκό
(NO)	Gul	Blå	Grå	Hvit	Grønn	Brun	Rød (1,00mm)	Svart	Svart/ Rød	Brun/ Hvit	Rød (2,50mm)	Hvit	Hvit
(PL)	Żółty	Niebieski	Szary	Biały	Zielony	Brazowy	Czerwony (1,00mm)	Czarny	Czarny/ Czerwony	Brazowy/ Biały	Czerwony (2,50mm)	Biały	Biały